



Reece-Hopper Sales LLC

Product Catalog

TABLE OF CONTENTS

	PAGE		PAGE
Access Doors & Panels	11	No-Hub Couplings	16
Anchors	7	Pipe Sleeving	8
Anchor Kit	7	Pliers	11
Auto Vent	7	Saddles	12
Backwater Valves	12	Sewer Relief Plugs	12
Cleanout Plugs	3	Shop Towels	10
Cleanouts	3	Shower Seats	2
Closet Flanges	4	Sink Frame Lugs	12
Closet Stabilizers	4	Soil Pipe Gaskets	12
Cover Plates, Stainless Steel	3	Spacer Flanges	5
Cut-Off Nipples	10	Tape	9
Drains		Duct Tape	9
General Purpose	3	Pipe Wrap Tape	9
Shower	3	Pipe Wrap Tape Primer	9
Snap In	3	Teflon Tape	9
Drop-in Anchors	7	Test Caps	6
Dryer Vent Kits & Accessories	7	Toggle Bolts	7
Escutcheons	8	Tools	11
EVERFLUX	11	Tracer Wire	10
Fireplace Valve Trim Kit	11	Urinal Flange Kits	5
Grab Bars	2	Valve Boxes	13
Green Drains	17	Water Meter Nipples	6
Hanger Iron	10		
Hose Clamps	15		
Insulation Semi-Slit & Seam Seal	1		
KRC-7	10		
Max-Adapter Tees	6		
Meter Boxes	13-14		

COMBINE RHC CATALOG ITEMS WITH THE PRODUCTS BELOW TO MAKE FFA



BARNES®

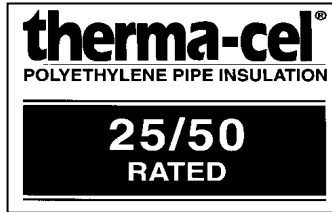

Temp range between -160° and 200°F

Pipe Insulation

SEMI-SLIT AND SEAM-SEAL (WITH TAPE) POLYETHYLENE PIPE INSULATION

3/8" WALL SIX (6)-FOOT LENGTHS

SEMI-SLIT	SEAM-SEAL	COPPER TUBE SIZE	IRON/PVC PIPE SIZE	FEET PER CARTON
58AS	58ASM	1/2"	3/8"	396
78AS	78ASM	3/4"	1/2"	276
118AS	118ASM	1"	3/4"	222
138AS	138ASM	1 1/4"	1"	180
158AS	158ASM	1 1/2"	1 1/4"	138
2AS	2ASM		1 1/2"	126
218AS	218ASM	2"		96
238AS	238ASM		2"	84
	258ASM	2 1/2"		72
	278ASM		2 1/2"	60
	318ASM	3"		54

1/2" WALL SIX (6)-FOOT LENGTHS

SEMI-SLIT	SEAM-SEAL	COPPER TUBE SIZE	IRON/PVC PIPE SIZE	FEET PER CARTON
58BS	58BSM	1/2"	3/8"	300
78BS	78BSM	3/4"	1/2"	240
118BS	118BSM	1"	3/4"	186
138BS	138BSM	1 1/4"	1"	150
158BS	158BSM	1 1/2"	1 1/4"	120
2BS	2BSM		1 1/2"	102
218BS	218BSM	2"		84
238BS	238BSM		2"	72
	258BSM	2 1/2"		60
	278BSM		2 1/2"	54
	318BSM	3"		48
	312BSM		3"	36
	418BSM	4"		30
	412BSM		4"	24

3/4" WALL SIX (6)-FOOT LENGTHS

SEMI-SLIT	SEAM-SEAL	COPPER TUBE SIZE	IRON/PVC PIPE SIZE	FEET PER CARTON
	58CSM	1/2"	3/8"	180
	78CSM	3/4"	1/2"	150

1" WALL SIX (6)-FOOT LENGTHS

SEMI-SLIT	SEAM-SEAL	COPPER TUBE SIZE	IRON/PVC PIPE SIZE	FEET PER CARTON
58DS	58DSM	1/2"	3/8"	120
78DS	78DSM	3/4"	1/2"	96

1PBT Pint of insulation adhesive for use on semi-slit insulation



GRAB BARS

1-1/2" Diameter, 18 gauge, type 304 stainless steel tubing. Easy to install. Standard satin finish. Includes stainless steel screws. All grab bars are concealed flange. Special order if not shown here.

STRAIGHT		VERT. ANGLE	TUB & SHOWER	WALL TO FLOOR
HCL12	12"	501632VHCRL	501834TSHCR	5033304
HCL18	18"	501632VHCRR	502042TSHCR	5033305LH
HCL24	24"			5033305RH
HCL30	30"			
HCL36	36"			
HCL42	42"			
HCL48	48"			

SHOWER SEATS

Stainless steel frame, fold-up shower seats. Available in naugahyde, phenolic or teak (special order). All shower seats must be installed using sufficient in-wall backing materials (not supplied).

FULL SIZE	COMPACT	FOLD-UP & REMOVABLE TUB
SH-400-NW-26 RH 26" x 22.5"	SH-410-NH 18" x 15"	SH-411-NH 32" x 15"
SH-401-NW-26 LH 26" x 22.5"	SH-410-PH 18" x 15"	SH-411-PH 32" x 15"
SH-400-NH RH 32" x 22.5"		SH-420-ADJ 26.5" x 15"
SH-401-NH LH 32" x 22.5"		
SH-400-PH RH 32" x 22.5"		
SH-401-PH LH 32" x 22.5"		

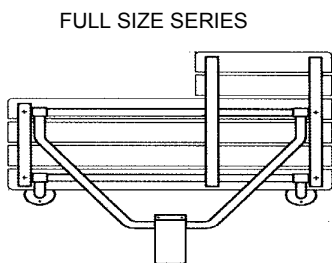

FULL SIZE SERIES

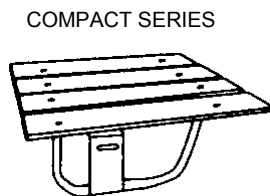

COMPACT SERIES

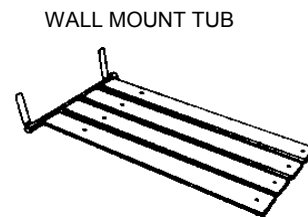

WALL MOUNT TUB

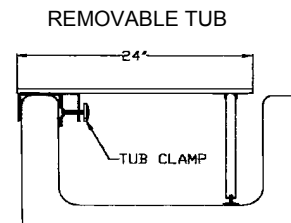

REMOVABLE TUB

NW & NH = naugahyde white cushion
PH = phenolic hard plastic slats

DRAINS

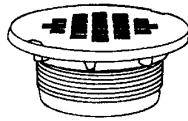

PART	DESCRIPTION	QUANTITY
RH101-PNC	PVC Shower Drain, Self Caulking, Compression Type, SS Top <i>Our most popular drain!</i> <i>Perfect for fiberglass showers.</i>	1/40

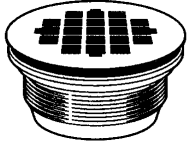

RH140-NC	Brass Shower Drain, Self Caulk, Compression Type, SS Top	1/40
----------	----------------------------------------------------------	------

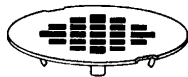

129-CP	Replacement Strainer Top Chrome	1
--------	---------------------------------	---

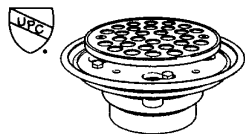

PART	DESCRIPTION	QUANTITY
114-23	PVC Shower Drain with Bolt Down Collar, SS Top UPC Approved	1/18

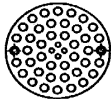

SS-G	SS Strainer Top for 114-23 & DD-2-T, 4 1/4"	
------	---------------------------------------------	--

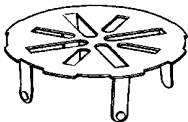

186-2	Snap-In SS Drain 2" for 1 1/2" pipe	1/72
186-3	Snap-In SS Drain 3" for 2" pipe	1/72
186-4	Snap-In SS Drain 4" for 3" pipe	1/72
186-5	Snap-In SS Drain 5" for 4" pipe	1/48

CLEANOUTS & ACCESSORIES

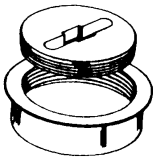

Also known as TomCaps *Countersunk*

PART	DESCRIPTION	QUANTITY
31200	PVC Internal Pipe Cleanout 2"	1/10
31300	PVC Internal Pipe Cleanout 3"	1/10
31400	PVC Internal Pipe Cleanout 4"	1/10

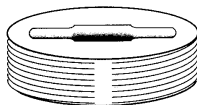

Also known as chevy plugs *Countersunk*

PART	DESCRIPTION	QUANTITY
BP13-2	PVC Cleanout Plug 2"	1/25
BP13-3	PVC Cleanout Plug 3"	1/25
BP13-3S	PVC Cleanout Plug 3 1/2"	1/25
BP13-4	PVC Cleanout Plug 4"	1/25



PART	DESCRIPTION	QUANTITY
C51-3	Stainless Steel Cover Plate 3"	1/25
C51-4	Stainless Steel Cover Plate 4"	1/25
C51-5	Stainless Steel Cover Plate 5"	1/25
C51-6	Stainless Steel Cover Plate 6"	1/25
C51-8	Stainless Steel Cover Plate 8"	1/25
C51-10	Stainless Steel Cover Plate 10"	1
B52	Cover Screw 1/4" x 4"	1/100



CLOSET FLANGES

PVC FLANGE WITH ADJUSTABLE METAL RING

FITS INSIDE 4" OR OVER 3" PVC PIPE



PART	SIZE	QUANTITY
LESS KNOCKOUT AFF34-M	4" X 3"	25 / CASE
WITH KNOCKOUT AFF34-MKO	4" X 3"	25 / CASE

OFFSET PVC FLANGE WITH ADJUSTABLE METAL RING

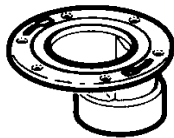

PART	SIZE	QUANTITY
AMR-34	4" X 3"	25 / CASE

PVC FLUSHTYPE FLANGE 4" X 3" & 3"

4" X 3" FITS INSIDE 4" OR OVER 3" PVC PIPE, 3" FITS INSIDE 3" PVC PIPE



PART	SIZE	QUANTITY
LESS KNOCKOUT FF34	4" X 3"	20 / CASE
12000	3"	20 / CASE

PVC FLANGE WITH 45 DEGREE OUTLET with METAL RING

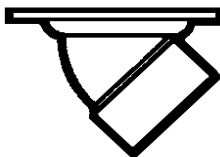

PART	SIZE	QUANTITY
4" X 3"		
213628WSS	4" X 3"	1/20

With adjustable stainless steel ring
(old part # 193628M)

CLOSET STABILIZER

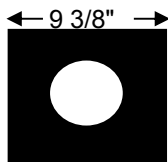

PART	SIZE	QUANTITY
CS-4	4"	75

Plastic closet stabilizer. Solvent welds to closet bend.

REPAIR CLOSET FLANGES

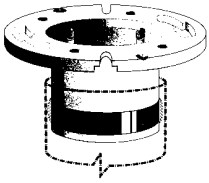

REPLACEMENT FLANGE

STREET COMPRESSION CLOSET FLANGE SLIDES INSIDE 4" PVC or CI PIPE

PART	SIZE	QUANTITY
DS950	4"	1/24

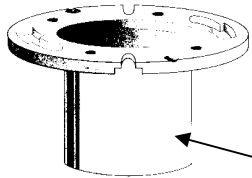

*ADJUSTABLE 3" X 4" CLOSET FLANGE WITH EXTENDED NECK
FITS INSIDE 4" AND OVER 3" PVC PIPE*

PART	SIZE	QUANTITY
GF340P	3" X 4"	1/12

Neck extends 5 1/2" from bottom of flange

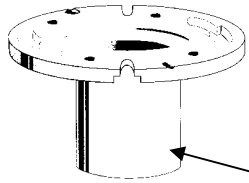

*ADJUSTABLE 3" CLOSET FLANGE WITH EXTENDED NECK
FITS INSIDE 3" PVC PIPE*

PART	SIZE	QUANTITY
IF333P	3"	1/12

Neck extends 4" from bottom of flange

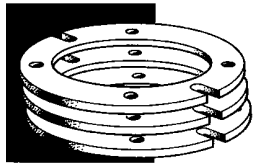

CLOSET FLANGE EXTENSION RING

USED TO REPAIR/RAISE THE CLOSET FLANGE. STACKABLE, SELF-SEALING

PART	DESCRIPTION	QUANTITY
KIT	Contains 3 extenders, 3-1/2" closet bolt kit, & 1 tube of sealant	
CF300P	1/4" THICK	1/12
SINGLE	1 Extender Flange With Header Card, Stackable	
CF350P	1/4" THICK	1/24
CF500P	1/2" THICK	1/12

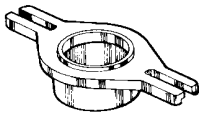

PART	DESCRIPTION	QUANTITY
16000	Urinal Flange Kit, 2" Spigot	1/20
16100	Urinal Flange Kit, 2" Hub	1/20

Includes Bolts and Gasket



SPACER FLANGE

PART	QUANTITY
SF100	1

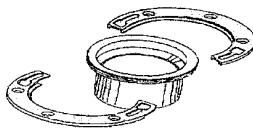

GALVANIZED REPAIR FLANGE & BOLT KIT

PART	QUANTITY
DSBF34	1/50

RUBBER TEST CAPS

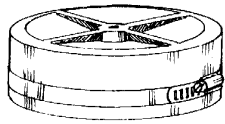

PART	DESCRIPTION	QUANTITY
DC-15	Rubber Test Cap 1 1/2"	1/100
DC-20	Rubber Test Cap 2"	1/100
DC-30	Rubber Test Cap 3"	1/50
DC-40	Rubber Test Cap 4"	1/50
DC-60	Rubber Test Cap 6"	1/20
DC-80	Rubber Test Cap 8"	1/16
DC-100	Rubber Test Cap 10"	1

SLIP-ON TEST CAPS

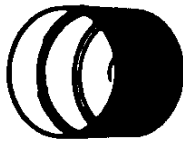

PART	DESCRIPTION	QUANTITY
STC-15	Slip-On Orange Test Cap 1 1/2"	100/900
STC-20	Slip-On Orange Test Cap 2"	100/900
STC-30	Slip-On Orange Test Cap 3"	25/300
STC-40	Slip-On Orange Test Cap 4"	20/200
STC-60	Slip-On Orange Test Cap 6"	1/78

WATER METER NIPPLES

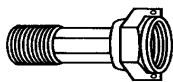

PART	DESCRIPTION	QUANTITY
105-784NL	Meter Nipple Brass w/Washer 3/4"	10/100
105-785NL	Meter Nipple Brass w/Washer 1"	10/100
Washers		
888-458	Washer for 105-784	25
888-459	Washer for 105-785	25

MAX-ADAPTER

EZ-CONNECT ADAPTER TEE - ADDS A 2ND OUTLET TO ANY SUPPLY STOP



PART	DESCRIPTION	QUANTITY
993-015NL	Max-Adapter 3/8" x 1/4"	10/80
993-016NL	Max-Adapter 3/8" x 3/8"	10/80

DRYER VENT KITS & ACCESSORIES

VENT KIT

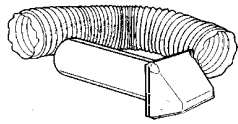

PART	OLD #	DESCRIPTION	QUANTITY
255	(EK45)	Flexible 4" x 5' Vinyl Hose with Aluminum Hood & Plastic Clamps	1
280		Flexible 4" x 5" UL Duct with Aluminum Hood & Metal Tension Clamps Recommended for Dryers	1

VENT HOODS

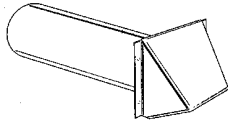

PART	OLD #	DESCRIPTION	QUANTITY
344	(VH424)	Aluminum 4" Vent Hood with Standard Tailpiece & Backplate	10/Ctn <small>Carton Quantities Only</small>

VENT HOSE

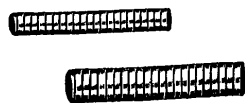

PART	OLD #	DESCRIPTION	QUANTITY
301		Flexible Aluminum Duct 3" x 8'	14/Ctn
302		Flexible Aluminum Duct 4" x 8' Compressed	8/Ctn <small>Carton Quantities Only</small>

AUTO-VENTS

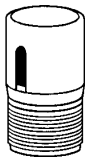

PART	DESCRIPTION	QUANTITY
V-200-P	Automatic Plumbing Vent 1 1/2"	1/50

ANCHORS

DROP-IN ANCHORS

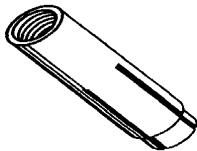

PART	DESCRIPTION	HOLE SIZE	QUANTITY
D38	Drop-in Anchor 3/8" X 1 9/16"	1/2"	100/600
D12	Drop-in Anchor 1/2" X 2"	5/8"	50/400

Drop-in anchors are used for overhead applications in solid media such as concrete, stone or cinder block. Ideal for hanging pipe, duct work, machinery, etc.

TOGGLE BOLTS

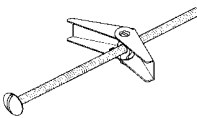

PART	DESCRIPTION	HOLE SIZE	QUANTITY
TB1440R	Toggle Bolt 1/4" x 4"	5/8"	50/400
TB1430R	Toggle Bolt 1/4" x 3"	5/8"	50/500

For use in hollow walls, plaster, hollow tile or block applications

ANCHOR KIT



PART	DESCRIPTION	QUANTITY
AK-1	Anchor Kit complete with 100pc 1 1/4" #10 Screws, Plastic Anchors, Drill Bit and Case	1/12

PLASTIC ESCUTCHEONS

Use as a solid escutcheon or snap apart and use as a split escutcheon.
 Chrome plated plastic - Unbreakable - Rustproof - Non Corrosive

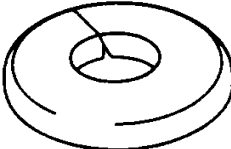
CHROME			
	PART	SIZE	QUANTITY
Copper Tube Size 	10-50C	CTS Escutcheon 1/2"	12/1500
	10-75C	CTS Escutcheon 3/4"	12/1500
	10-100C	CTS Escutcheon 1"	12
	10-125C	CTS Escutcheon 1 1/4"	12
	10-150C	CTS Escutcheon 1 1/2"	12
	10-200C	CTS Escutcheon 2"	12

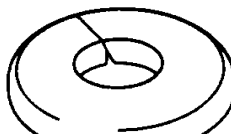
CHROME			
	PART	SIZE	QUANTITY
Iron Pipe Size 	10-50	IPS Escutcheon 1/2"	12/1500
	10-75	IPS Escutcheon 3/4"	12/1500
	10-100	IPS Escutcheon 1"	12
	10-125	IPS Escutcheon 1 1/4"	12
	10-150	IPS Escutcheon 1 1/2"	12
	10-200	IPS Escutcheon 2"	12

WHITE			
	PART	SIZE	QUANTITY
	10-250W	IPS Escutcheon 2 1/2"	12

PIPE SLEEVE



PART	DESCRIPTION	QUANTITY
DS-123-R	Red Pipe Sleeve 200' Roll, 6 Mil Thick	1/20
DS-123-B	Blue Pipe Sleeve 200' Roll, 6 Mil Thick For use with up to 1" pipe.	1/20
DS-2	Blue Pipe Sleeve 200' Roll, 6 Mil Thick For use with up to 2" pipe.	1/12
DS-3	Blue Pipe Sleeve 200' Roll, 6 Mil Thick For use with up to 3" pipe.	1 roll
DS-346	Blue Pipe Sleeve 400' Roll, 6 Mil Thick For use with up to 6" pipe.	1 roll



<i>Extra Thick</i>		
DS-123-R25	Red Pipe Sleeve 100' Roll, 25 Mil	1/9
DS-123-B25	Blue Pipe Sleeve 100' Roll, 25 Mil	1/9

TAPE

DUCT TAPE

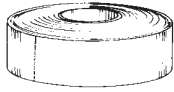

PART	DESCRIPTION	QUANTITY
219-2	Gray Duct Tape 2" x 60 YD	24
337	Foil Tape 2" x 50 YD	24
223-2	Black UV Resistant Duct Tape 2" x 60 YD	24

SEALING TAPE

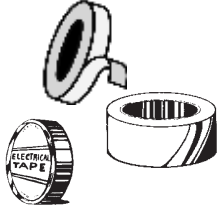

PART	DESCRIPTION	QUANTITY
SW-400	Hi-Strength Filament Tape 3/4" x 60 YD	48
518	Clear Box Tape 2" x 110 YD	36
300-1	Electrical Tape 3/4" x 60 FT, 7mil	10
SS111	Heavy Stretch Wrap 18" x 1500 FT	4

TEFLON TAPE

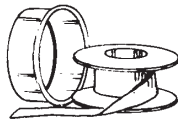

PART	DESCRIPTION	QUANTITY
1-260	1/2" x 260"	100/box 500/case
1-520	1/2" x 520"	100/box 500/case
2-260	3/4" x 260"	70/box 350/case
2-520	3/4" x 520"	70/box 350/case
3-260	1" x 260"	50/box 250/case
3-520	1" x 520"	50/box 250/case

PIPE WRAP



PART	DESCRIPTION	QUANTITY
20-2	2" X 100' ,20 mil, UPC Approved, Black	24
10-2	2" X 100' ,10 mil, UPC Approved, Black	36
826-2B	2" x 100' ,12 mil, Black	24
826-2Y	2" x 100' ,12 mil, Yellow	24
826-4Y	4" x 100' ,12 mil, Yellow	12

PRIMER



PART	DESCRIPTION	QUANTITY
P-27	Pipe Wrap Primer, Quart	4

KRC-7

Removes soap scum, hard water stains, rust, mineral deposits from tile, fiberglass, stainless, and glass.



PART	DESCRIPTION	QUANTITY
1832	KRC-7 Cleaner Restorer 32 Ounce	18
2416	KRC-7 Cleaner Restorer 16 Ounce	24

SHOP TOWELS



PART	DESCRIPTION	QUANTITY
75090	Shop Towels in a Box	12

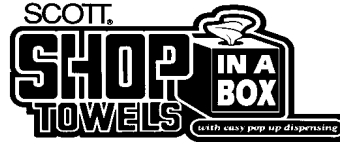

HANGER IRON

24 Gauge

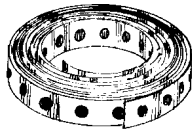

PART	DESCRIPTION	QUANTITY
2242	Galvanized Hanger Strap 3/4" x10'	50
4442	Galvanized Hanger Strap 3/4" x100'	10

TRACER WIRE



PART	DESCRIPTION	QUANTITY
TW18	500' roll x 18 gauge solid strand yellow wire Used for underground tracer wire for P.E., steel, and plastic gas lines.	1/4

CUT-OFF NIPPLES



PART	DESCRIPTION	QUANTITY
N-011	Plastic Cut-off Nipple 1/2" x 6"	50/800
N-012	Plastic Cut-off Nipple 3/4" x 6"	25/400
N-013	Plastic Cut-off Nipple 3/4" x 1/2" x 6"	40/640

TOOLS

PART	DESCRIPTION	QUANTITY
KTK-01	Fireplace Valve Trim Kit	1/24

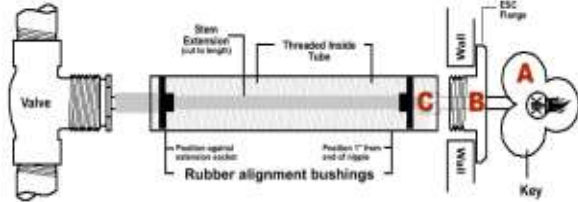

Includes key (A), trim flange (B), threaded extension tube (C) and fittings

Made in the USA

ANGLE PLIERS

PART	DESCRIPTION	QUANTITY
G-254	Angle Nose Pliers 11" Notched Red Handle	5/25



EVERFLUX

PART	DESCRIPTION	QUANTITY
EV-1	Water Soluble Flux Paste 80 ml.	1/100
EV-2	Water Soluble Flux Paste 250 ml.	1/36



EVERFLUX THE WORLD'S BEST WATER SOLUBLE FLUX

ACCESS DOORS

Prime Coated Steel, Standard Screwdriver Latch

PART	SIZE
ED0606	6 x 6
ED0808	8 x 8
ED1010	10 x 10
ED1212	12 x 12
ED1414	14 x 14
ED1616	16 x 16
ED1818	18 x 18
ED2424	24 x 24
ED2436	24 x 36



Stainless steel and cylinder lock options available by special order. Please call for quotes.

Plastic Flush to Frame Doors, Snap Latch

PART	SIZE
PA0609	6 x 9
PA0808	8 x 8
PA1212	12 x 12
PA1414	14 x 14
PA1429	14 x 29
PA1818	18 x 18
PA2222	22 x 22
51203	12 x 12

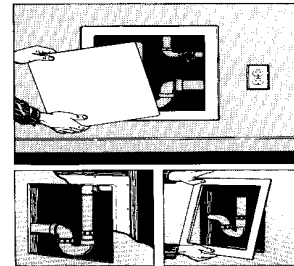

Plastic access panel, no frame 20/box - box quantities only

BACKWATER VALVES



PART	DESCRIPTION	QUANTITY
223283W	PVC Backwater Valve 3"	1/10
223284W	PVC Backwater Valve 4"	1/4

SINK FRAME LUGS

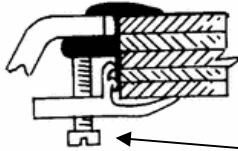

PART	DESCRIPTION	QUANTITY
QN1612C	Bag Of 12 Lugs for Series 300 Frame	1

← 12 lugs and bolts per bag

SEWER RELIEF PLUGS

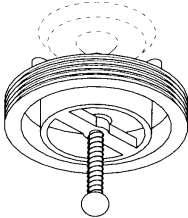

PART	DESCRIPTION	QUANTITY
SRP-30	Sewer Relief Plug 3"	1
SRP-40	Sewer Relief Plug 4"	1

SOIL PIPE GASKET

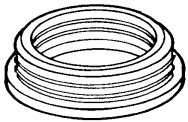

PART	DESCRIPTION	QUANTITY
DT-02	Service Weight Gasket 2"	1/150
DT-03	Service Weight Gasket 3"	1/75
DT-04	Service Weight Gasket 4"	1/60
DT-06	Service Weight Gasket 6"	1/30

SADDLES



Securely fits 6" to 12" pipe complete with clamps

PART	DESCRIPTION	QUANTITY
DFW-4TC	Flexible Rubber Saddle Tee 4" Inlet	1/12
DFW-6TC	Flexible Rubber Saddle Tee 6" Inlet	1/6

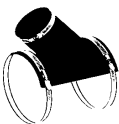

DFW-4YC	Flexible Rubber Saddle Wye 4" Inlet	1/6
DFW-6YC	Flexible Rubber Saddle Wye 6" Inlet	1/4

550-188	Quick Release Saddle Clamp	1
---------	----------------------------	---

VALVE AND METER BOXES

VALVE BOXES

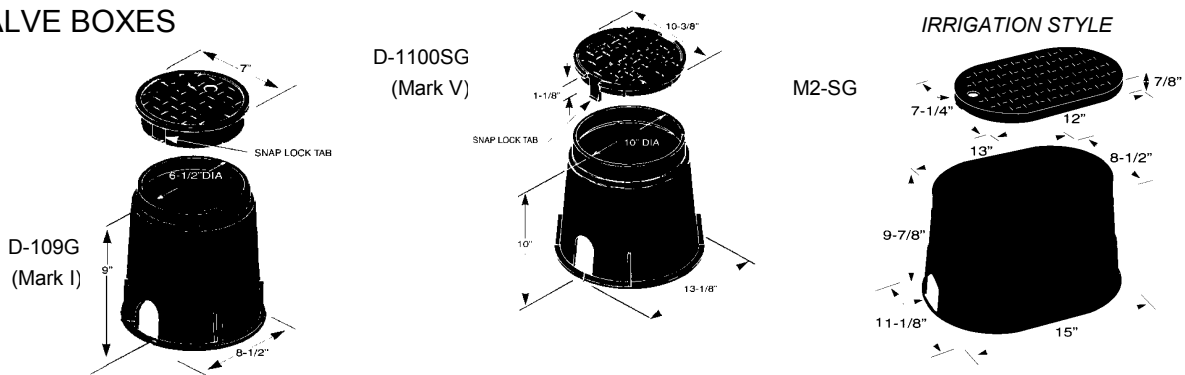

PART	SIZE AND DESCRIPTION	QUANTITY
D-109G	6" Round Valve Box With Green Lid	36/Ctn or 900/Skid
D-109P	6" Round Valve Box With Purple Lid	36/Ctn or 900/Skid
D-1100SG	10" Round Valve Box With Green Lid	11/Bndl or 99/Skid
M2-SG	Small Oval Valve Box with Solid Green Lid	11/Bndl or 132/Skid

LIDS

L-109	Green Lid Only For 6" Valve Box
L-109P	Purple Lid Only For 6" Valve Box
L-1100SG	Green Lid Only For 11" Valve Box

METER BOXES

D-1000 Series

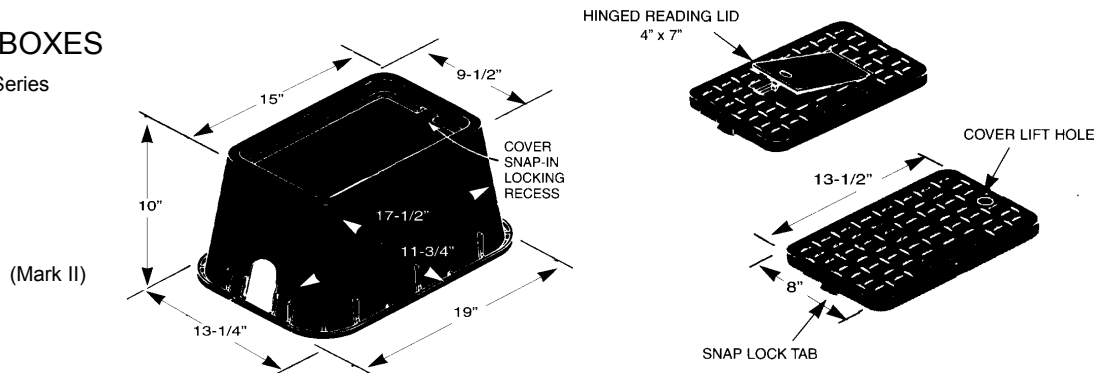

PART	SIZE AND DESCRIPTION	QUANTITY
DFW1000.101R	Economy Meter Box With Black Reader Lid	12/Bndl or 96/Skid

LIDS

L-1000RB	Black Reader Lid Only For D-1000 Box
----------	--------------------------------------

METER BOXES

STANDARD METER BOXES

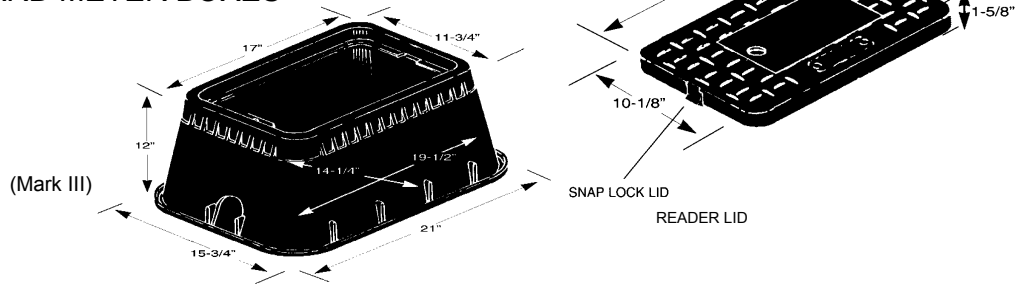

PART	SIZE AND DESCRIPTION	QUANTITY
DFW1200.121R	Standard Meter Box with Black Reader Lid	12/Bndl or 54/Skid
DFW1200X.12R	Dual Outlet Meter Box w/ Black Reader Lid	12/Bndl or 54/Skid

LIDS

L-1200RB Black Reader Lid Only For D-1200 Box

JUMBO METER BOXES

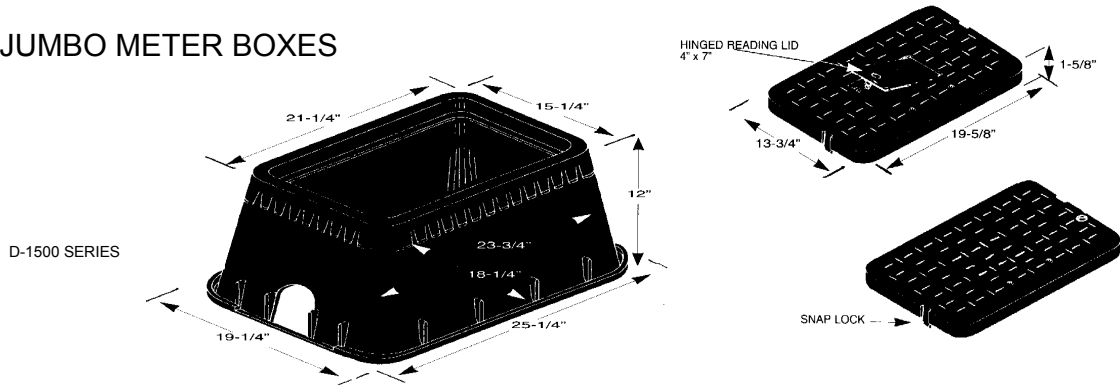

DFW1500.121R Jumbo Meter Box with Black Reader Lid 12/Bndl or 32/Skid

LIDS

L-1500RB Black Reader Lid Only For D-1500 Box
 L-1500SG Solid Green Lid Only For D-1500 Box

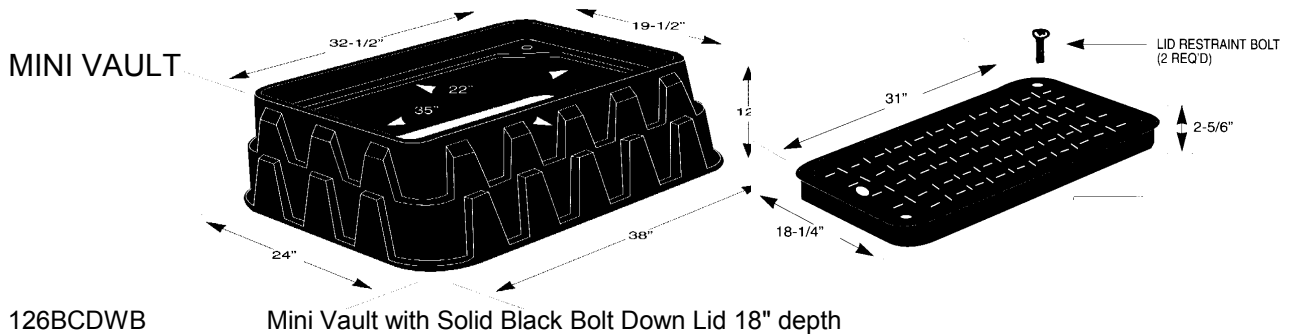

126BCDWB Mini Vault with Solid Black Bolt Down Lid 18\"/>

HOSE CLAMPS

10 per box and 100 per case

$$\text{Length} = d \times 3.14$$

PART S.S.	ALL S.S.	SIZE	
PART #	PART #	MINIMUM	MAXIMUM
600-006	620-006	3/8"	7/8"
600-008	620-008	7/16"	1"
600-010	620-010	9/16"	1 1/16"
600-012	620-012	9/16"	1 1/4"
600-016	620-016	11/16"	1 1/2"
600-020	620-020	3/4"	1 3/4"
600-024	620-024	1 1/16"	2"
	620-028	1 5/16"	2 1/4"
	620-032	1 9/16"	2 1/2"
	620-036	1 13/16"	2 3/4"
	620-040	2 1/16"	3"
	620-044	2 5/16"	3 1/4"
	620-048	2 9/16"	3 1/2"
	620-052	2 13/16"	3 3/4"
	620-056	3 1/16"	4"
	620-060	3 5/16"	4 1/4"
	620-064	2 1/2"	4 1/2"
	620-072	3"	5"
	620-080	3 1/2"	5 1/2"
	620-088	4"	6"
	620-096	4 1/2"	6 1/2"
	620-104	5"	7"
	620-128	6 1/2"	8 1/2"
	620-152	2"	10"
	620-200	11"	13"
	620-212	11 3/4"	13 3/4"
	620-270	15 3/8"	17 3/8"



QUICK RELEASE - ALL STAINLESS

PART #	SIZE	
	MINIMUM	MAXIMUM
550-188	2 1/16"	12 5/16"
550-216	10 3/16"	14"
550-248	1 3/4"	16"
550-312	2"	20"



MINI CLAMPS - ALL STAINLESS

PART #	SIZE	
	MINIMUM	MAXIMUM
350-004	7/32"	5/8"
350-006	5/16"	7/8"





PART	DESCRIPTION	QUANTITY
GD102	2" Waterless Trap Seal	1/24
GD103	3" Waterless Trap Seal	1/24
GD1035	3.5" Waterless Trap Seal	1/24
GD104	4" Waterless Trap Seal	1/24

